

Contents

Contents	1
Preface	2
1 Your product	3
1.1 Options.....	3
2 Before use	4
2.1 Intended use	4
2.2 General safety instructions.....	4
2.3 Symbols on the tricycle	5
2.4 Moving the tricycle	5
2.5 Storage	5
3 Using your tricycle	6
3.1 Operating the brakes.....	6
3.2 Operating the gear shifter (only 2215).....	7
3.3 Adjusting the saddle.....	7
4 Maintenance	8
4.1 Points of maintenance.....	8
4.2 Maintenance instructions	8
4.3 Troubleshooting	8
4.4 Expected lifespan.....	9
4.5 Reuse.....	9
4.6 End of use.....	9
5 Technical specifications	10



Preface

Congratulations! You are now owner of a Vermeiren tricycle!

This tricycle is made by qualified and committed personnel. It is designed and produced according to high quality standards, guarded by Vermeiren.

Please read this manual carefully; it will help you to get familiar with the operation, capabilities and limitations of your tricycle.

If you still have questions after reading this manual, do not hesitate to contact your specialist dealer. He/she will be glad to help you.

Important note

To ensure your safety, and to prolong the lifetime of your product, please take good care of it and have it checked and serviced on a regular basis.





This manual reflects the latest product developments. Vermeiren has the right to implement changes to this type of product without any obligation to adapt or replace similar products previously delivered.

Pictures are used to clarify the instructions in this manual. Details of the depicted product may deviate from your product.

Information available

On our website <http://www.vermeiren.com/> you will always find the most recent version of the information in this manual. Please consult this website regularly for possible updates.

Visually impaired people can download the electronic version of this manual and have it read out by means of a text-to-speech software application.

	User manual	For user and specialist dealer
	Installation instructions	For specialist dealer
	Service manual for tricycles	For specialist dealer
	EC declaration of conformity	

1 Your product



1. Handgrips
2. Bell
3. Handlebar
4. Brake levers
5. Front reflector
6. Mudguards
7. Front brakes
8. Front wheel
9. Frame
10. Pedals
11. Chain cover
12. Rear wheels
13. Rear reflector
14. Tray
15. Saddle
16. Identification plate

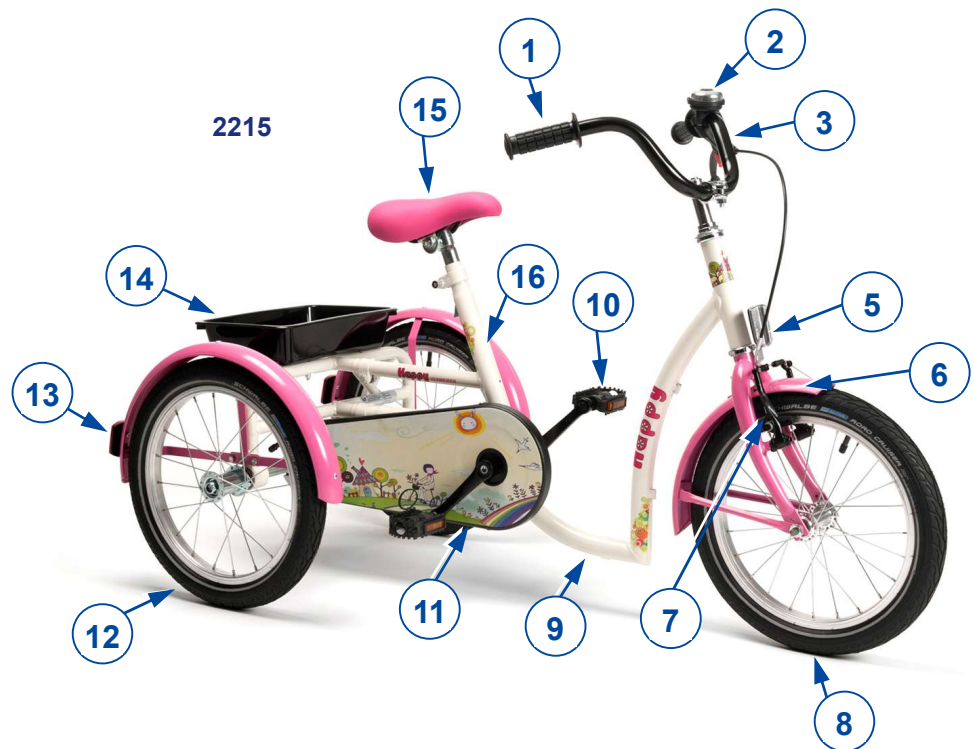

1.1 Options

Contact your specialist dealer about options. He will gladly advise you.

2 Before use

2.1 Intended use

- Indications and contraindications: The user can ride the tricycle by himself. The tricycle is intended for people with stiff or damaged joints, heart insufficiencies or poor blood circulation, balance disturbances, cachexia, ... You should NOT use this tricycle if you suffer from physical or mental impairments that may put you, or other people, in danger while driving. For this reason, consult your doctor first and make sure that your specialist dealer is informed about his advice.
- The tricycle is suitable for outdoor use.
- The tricycle is designed and produced solely to transport 1 person with a maximum weight as specified in §5. It is not designed for transportation of heavy goods or objects, nor for any use other than previously described.
- Only use accessories and spare parts approved by Vermeiren.
- Please read all technical details and limits of your tricycle in chapter 5.
- The warranty on this product is based on normal use and maintenance as described in this manual. Damage to your product caused by improper use or lack of maintenance will cause the warranty to lapse.

2.2 General safety instructions



CAUTION

Risk of injuries and/or damage

Carefully read and follow the instructions in this manual. Otherwise you may get injured or your tricycle may get damaged.

Keep the following general warnings in mind during use:

- Do not use your tricycle if you are under influence of alcohol, medicines or other substances that may influence your riding abilities.
- Be aware that some parts of your tricycle may get very hot or cold due to ambient temperature, solar radiation or heating devices. Be careful when touching. Wear protective clothing if the weather is cold.
- Do not modify your tricycle in any way.
- To prevent injury and/or damage to your tricycle, make sure that no objects and/or body parts are caught in the spokes of the wheels.
- Investigate the effects of shifting the centre of gravity on the behaviour of the tricycle, for example on up or down gradients, on laterally sloping ground, or when overcoming obstacles.
- The tricycle must be used according the applicable traffic regulations.
- Adapt your riding to weather and traffic conditions.
- To be better visible when riding in the dark, wear the brightest possible clothing or clothes with reflectors, and check that the reflectors mounted on the front and rear of the tricycle are clearly visible.
- Never exceed the maximum load of your tricycle.
- Be careful when riding in bends the tricycle can loss sideways stability.

In case a serious incident has occurred involving your product, notify Vermeiren or your specialist dealer as well as the competent authority in your country.

2.3 Symbols on the tricycle



Maximum weight of the user in kg



Type designation

2.4 Moving the tricycle

The best way to move the tricycle is to make use of the wheels and roll the tricycle to the desired place.

2.5 Storage

- i** Make sure that your tricycle is stored in a dry environment to prevent mould from growing and the upholstery from being damaged, see also chapter 5.

3 Using your tricycle



WARNING

Risk of injuries

- First read previous chapters and inform yourself about the intended use. Do NOT use your tricycle unless you have read and fully understood all instructions.
- In case of doubts or questions, do not hesitate to contact your local specialist dealer, your care provider or technical adviser to help you with this.

3.1 Operating the brakes



WARNING

Risk of injuries

- Good operation of the brakes is influenced by wear and contamination of the tires (water, oil, mud, ...) – Check the condition of the tires before each use.
- The brakes are adjustable and can wear – Check the operation of the brakes before each use.

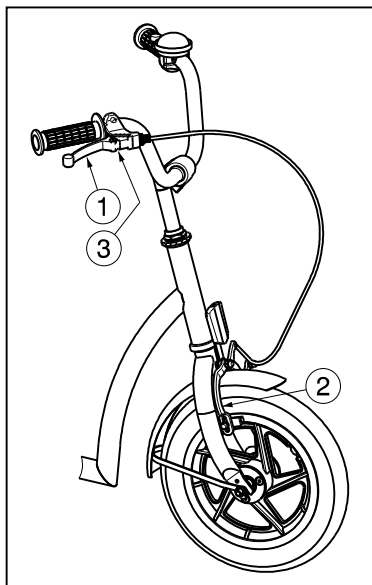

To apply the front wheel brake:

1. Push the brake lever ① to the handgrip.
2. The brake ② shall be pressed against the front wheel.

To release the front wheel brake:

1. Release the brake lever ①.

Activating the parking brakes: Block the brakes by pushing the plate ③.

The rear wheel brake can be activated with the same instructions like the front wheel brake. Left or right side lever can be chosen with the purchase.

To apply the torpedo brake ② on the rear wheels:

1. Turn the pedals ① backwards.

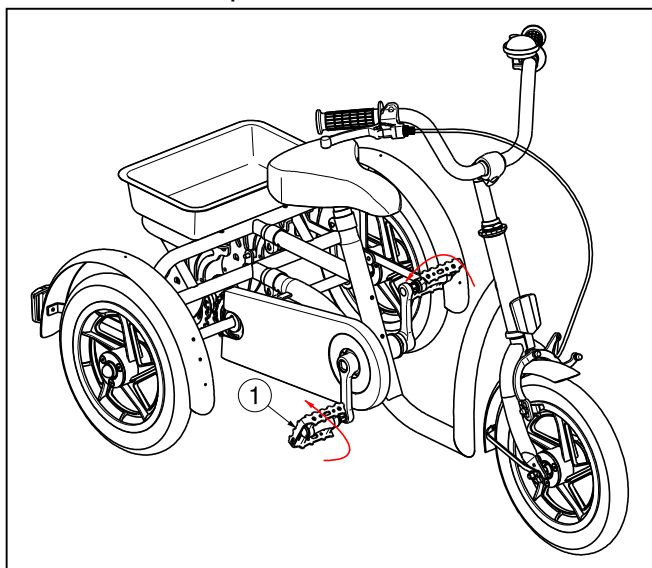

3.2 Operating the gear shifter (only 2215)

⚠ CAUTION: Risk of injury - Be sure to shift the lever one gear at a time, and reduce the force being applied to the pedals during shifting. If you try to force operation of the shifting lever while the pedals are being turned strongly, your feet may come off the pedals and the tricycle may topple over.

Turn the shift lever to shift to each of the three gears.

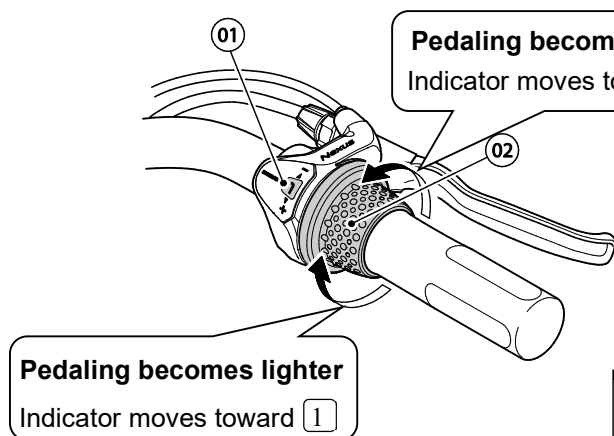

1 = Indicator
2 = Shift lever

1	Starting / Riding on sandy or rough road surfaces / Riding up slopes / Carrying heavy loads / Riding into head winds / When the light is illuminated
2	Riding on flat road surfaces
3	Riding at high speeds

3.3 Adjusting the saddle

⚠ CAUTION: Risk of injury - Never adjust the saddle when the user is sitting on the saddle.

⚠ CAUTION: Risk of injury – Check that the saddle is firmly secure before using the tricycle.



Adjust the height of the saddle as follow (stepless):

1. Loosen the screw ①.
2. Adjust the height of the saddle ② to a comfortable position.
3. Tighten the screw ① properly.

The maximum height is indicated with a straight line.

4 Maintenance

4.1 Points of maintenance

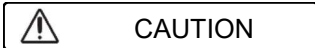

CAUTION

Risk of injuries and damage

Repairs and replacements may only be undertaken by trained persons and only genuine replacement parts of Vermeiren should be used.

i The service frequency depends on the frequency and intensity of use. Contact your dealer to agree to a common timetable for inspection/maintenance/repair.

For the maintenance manual, refer to the Vermeiren website: www.vermeiren.com.

Before each use

Inspect the following points:

- All parts: Present and undamaged or unworn.
- All parts: Clean, see § 4.2.2.
- Condition of wheels/tyres, see § 4.2.1;
- Condition of frame parts: No deformation, instability, weakness or loose connections
- Brakes: Undamaged and functioning.

Contact your specialist dealer for possible repairs or part replacements.

Yearly or more often

Have your tricycle inspected and serviced by your specialist dealer, at least once a year, or more often. The minimum maintenance frequency depends on use and should therefore be commonly agreed upon with your specialist dealer.

4.2 Maintenance instructions

4.2.1 Wheels and tyres

i Proper working of the brakes depends on the state of the tyres, and can change due to wear and contamination (water, oil, mud, ...).

Keep your wheels free of wires, hair, sand and fibres.

Check the profile of the tyres. If the tread depth is less than 1 mm, the tyres need to be replaced. Contact your specialist dealer for this matter.

Inflate each pneumatic tyre to the correct pressure (see pressure indication on the tyres).

4.2.2 Cleaning

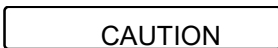

CAUTION

Risk of damage by moisture

Never use a hose or high-pressure cleaner to clean the tricycle.

Wipe all rigid parts with a damp cloth (not drenched). If necessary, use a mild soap, suitable for varnishes and synthetics.

The upholstery can be cleaned with lukewarm water and a mild soap. Do not use abrasive cleaning agents to clean.

4.2.3 Disinfection



CAUTION

Risk of damage

Disinfections may only be undertaken by trained persons. Consult your specialist dealer.

4.3 Troubleshooting

Even if you use your tricycle properly, a technical problem may occur. In this case, contact your local specialist dealer.



WARNING

Risk of injuries and damage

NEVER repair your tricycle yourself attempting to solve the problem.

The following symptoms may indicate a serious problem. Therefore always contact your specialist dealer if you spot any of the following deviations:

- Strange sound;
- Uneven tread wear on one of the tyres;
- Jerky movements;
- Damaged or broken wheel assemblies.

4.4 Expected lifespan

Your tricycle is constructed of aluminium components. The average lifespan of your tricycle is 5 years. Depending on the frequency of use, driving circumstances and maintenance, the lifespan will increase or decrease.

4.5 Reuse

Before each reuse, have the tricycle disinfected, inspected and serviced according to the instructions in §4.1 and §4.2.

4.6 End of use

At end of life, you need to dispose your tricycle according to the local environmental legislation. The best way to do so, is to disassemble the tricycle to facilitate the transport of recyclable parts.

5 Technical specifications

Technical terms below are valid for the tricycle in standard settings.

Brand	Vermeiren
Type	Tricycle
Name	2202, 2215

Description	2202 Aqua, Safari	2215 Sporty, Happy
Maximum occupant mass	40 kg	60 kg
Maximum load basket	5 kg	5 kg
Overall width	648mm	648mm
Overall length	1110mm	1294mm
Overall height	726mm - 838 mm	827mm - 940mm
Total mass	14,05kg	16,5kg
Maximum safe slope	7°	7°
Ground clearance	85mm	100mm
Height frame tube (entry height)	118mm	133mm
Diameter front tires	12`` x 2.00	16``x1.75
Pressure front tires	2.4-3 bar	2.0 bar
Diameter rear tires	12`` x 2.00	16``x1.75
Pressure rear tires	2.4-3 bar	2.0 bar
Height saddle	455mm - 570mm	610mm - 760mm
Distance between saddle and pedal	345mm - 470mm	480mm - 650mm
Height handgrips (measured from the ground)	It depends on handlebar model and stem	It depends on handlebar model and stem
Minimum height pedal	108mm	112mm
Maximum height pedal	287mm	361mm
Distance between saddle and steering	218mm - 229mm Adjustable: 0 mm	279mm - 303 mm Adjustable: -20 mm
Turning diameter	2000mm	2350mm
Rear gear	-	3
Front gear	-	-
Gear ratio	-	184%
Brakes	Clamp brake – Front; Torpedo - Rear	V-brake – Front; Torpedo – Rear
Storage and use temperature	+ 5 °C - +41°C	
Storage and use humidity	30% - 70%	
We reserve the right to introduce technical changes. Measurement tolerance ± 15 mm / 1,5 kg / 1,5°		

Table 1: Technical specifications

**Service registration form**

This product (name):

was inspected (I), serviced (S), repaired (R) or disinfected (D):

By (stamp): Kind of work: I / S / R / D Date:	By (stamp): Kind of work: I / S / R / D Date:	By (stamp): Kind of work: I / S / R / D Date:
By (stamp): Kind of work: I / S / R / D Date:	By (stamp): Kind of work: I / S / R / D Date:	By (stamp): Kind of work: I / S / R / D Date:
By (stamp): Kind of work: I / S / R / D Date:	By (stamp): Kind of work: I / S / R / D Date:	By (stamp): Kind of work: I / S / R / D Date:
By (stamp): Kind of work: I / S / R / D Date:	By (stamp): Kind of work: I / S / R / D Date:	By (stamp): Kind of work: I / S / R / D Date:
By (stamp): Kind of work: I / S / R / D Date:	By (stamp): Kind of work: I / S / R / D Date:	By (stamp): Kind of work: I / S / R / D Date:



Vermeiren GROUP
Vermeirenplein 1 / 15
2920 Kalmthout
BE

website: www.vermeiren.com

Instructions for specialist dealer

This instruction manual is part and parcel of the product and must accompany every product sold.

Version: G, 2023-03

Basic UDI: 5415174 1218062202 4U
5415174 1218062215 55

All rights reserved, including translation.