

# VERMEIREN

## Venus 4 Sport

INSTRUCTION MANUAL







# Contents

<b>Contents</b> .....	<b>1</b>
<b>Preface</b> .....	<b>2</b>
<b>1 Product description</b> .....	<b>3</b>
1.1 Intended Use.....	3
1.2 Safety instructions.....	4
1.3 Technical specifications.....	5
1.4 Accessories.....	6
1.5 Components.....	7
1.6 Location identification plate.....	8
1.7 Explanation of symbols.....	8
<b>2 Use</b> .....	<b>9</b>
2.1 Remarks on electromagnetic compatibility (EMC).....	9
2.2 Carrying the scooter.....	10
2.3 Assembly and disassembly of the scooter.....	10
2.4 Operating the brakes.....	11
2.5 Transfer in and out the scooter.....	11
2.6 Correct position in the scooter.....	11
2.7 Driving the scooter.....	11
2.8 Driving the scooter on ramps.....	14
2.9 Driving the scooter over steps.....	14
2.10 Operator control.....	14
2.11 Neutral.....	16
2.12 Transport in the car.....	16
2.13 Automatic Power shut down.....	17
2.14 Charging the batteries.....	17
2.15 Battery indicator.....	18
<b>3 Installation and adjustment</b> .....	<b>19</b>
3.1 Tools.....	19
3.2 Manner of delivery.....	19
3.3 Mounting or removing the rear and front frame.....	19
3.4 Adjusting angle of the steering column.....	19
3.5 Mounting / removing the shopping basket.....	20
3.6 Adjusting the seat.....	20
3.7 Folding the backrest.....	22
3.8 Adjusting the armrests.....	22
3.9 Locking steering wheels.....	22
3.10 Tyre changing.....	23
3.11 Thermal fuses.....	24
3.12 Anti-tipping.....	24
3.13 Changing the batteries.....	24
<b>4 Maintenance</b> .....	<b>25</b>
4.1 Cleaning.....	25
4.2 Reuse.....	25
4.3 Expected lifespan.....	25
4.4 End of use.....	25



## Preface

First of all we want to thank you for putting your trust in us by selecting one of our scooters.

The expected lifetime of your scooter is strongly influenced by the care and maintenance of the scooter.

This manual will help you get acquainted with the operation of your scooter.

Following the user instructions and the maintenance instructions are an essential part of the warranty.

This manual reflects the latest product developments. Vermeiren has the right to introduce changes without the obligation to adapt or replace previously delivered models.

For any further questions, please consult your specialist dealer.

# 1 Product description

## 1.1 Intended Use

The scooter is intended to comfortably transfer people. This scooter is designed to transfer 1 person. Do not carry passengers on your scooter (including children).

The scooter is designed to transfer adult people only, no goods, nor any persons under the age of 16.

Neither should it be used by people obviously suffering from physical or mental limitations that render them incapable of safely handling the scooter in traffic.

These limitations could involve:

- hemiplegics or paraplegics
- loss of limbs (arm amputation)
- limb defects or deformations (if resulting in reduced equilibrium and steering abilities)
- contractures or damaged joints (if resulting in reduced equilibrium and steering abilities)
- balance disturbances
- cachexia (decrease in muscle)
- mental disorders
- damage to the cerebral cortex owing to psychological disorders
- visual impairment

The scooter is classified as class A.

The scooter is suited for indoor and limited outdoor use by the occupant.

When providing for individual requirements:

- body size and weight (max. 115 kg)
- physical and psychological condition
- residential circumstances
- environment

should be taken into consideration.

Your scooter should be used on flat surfaces where all four wheels are touching the ground and where there is sufficient contact to propel the wheels equally.

You should practice for use on uneven surfaces (cobblestones, etc.), slopes, curves and to get past obstacles (curbs, etc.).

The scooter should not be used as a ladder, nor is it a transport for heavy or hot objects.

When using your scooter on streets or footpaths, local laws and regulations apply.

The scooter can be used on sidewalks. Under no circumstances the scooter may be used for driving on larger roads or expressways.

Use only Vermeiren approved accessories.

The manufacturer is not liable for damage caused by the lack of or improper service or as a result of not following instructions from this manual.





























Compliance with the user and maintenance instructions are an essential part of the warranty conditions so we recommend that you read the following pages very carefully.

Visually impaired people can contact the dealer for the instructions for use.

No complications are known for the scooter.



## 1.2 Safety instructions

-  Use only Vermeiren approved accessories.
-  Before getting on or off, taking apart or transporting your scooter, turn the start key to the “off” position.
-  When transporting the scooter, no persons may be transferred along with it.
-  Test the effects on the handling of the scooter when its center of gravity is shifted, for example on up or down gradients, on laterally sloping ground or when driving over uneven terrain.
-  Do not drive on roads with heavy traffic or roads that are muddy, gravelly, bumpy, narrow, snowed over, icy or canal towpaths not guarded by any fence or hedge.
-  Keep away from places where you might get the wheels stuck.
-  Pay attention that your clothes do not tangle in the wheels.
-  When picking up objects lying in front of, next to, or behind the scooter, take care that you do not lean too far sideways: risk of tipping over.
-  Avoid putting your scooter into the free-wheeling position on slopes.
-  Never reverse uphill.
-  Reduce speed when you go round corners.
-  Do not take the scooter onto escalators.
-  While driving, hold the handgrips with both hands.
-  Put your legs and feet on the surfaces provided for them during the drive.
-  Do not use your scooter at night or in raining, snowing, misty or heavy windy conditions.
-  When storing or parking your scooter outside, protect it with a shrouding cover against humidity.
-  High levels of humidity or very cold conditions can reduce the performance of your scooter.
-  Use your scooter strictly in accordance with regulations. Avoid driving straight over obstacles (e.g. step, edge of the curb) or down from high ledges.
-  Obey traffic regulations when driving on public roads. Please take other road-users into consideration.
-  As is the case with any other vehicle, you must never be under the influence of alcohol or medicine while driving your scooter. This also applies to indoor driving.
-  When traveling outdoors, adapt your driving to weather and traffic conditions.
-  When driving in the dark, wear bright clothing or clothing with reflectors to be more visible, and make sure that the reflectors on the scooter are clearly visible and drive with lighting on.
-  Make sure that the lights of your scooter are free from dirt and/or other objects that could hide them.
-  Never use your scooter as a seat in an automobile or other vehicle.
-  Check that the profile depth of the tyres is adequate.
-  If your scooter has pneumatic tyres, be careful to inflate them to the correct pressure (*see pressure indication on the tyres*) for optimal steering and stability of the scooter.
-  Make sure that the maximum load of the scooter is not exceeded.
-  Do not overload the shopping basket. The maximum load of the shopping basket is 3 kg.

## 1.3 Technical specifications

Technical terms below are valid for the scooter in standard settings and optimum environmental conditions. If other accessories are used, the tabulated values will change. Changes in outdoor temperatures, humidity, uphill, downhill, soils and battery levels can reduce output.

<b>Brand</b>	<b>Vermeiren</b>
<b>Type</b>	<b>Rear wheel drive scooters, Class A</b>
<b>Maximum load</b>	<b>115 kg</b>
<b>Model</b>	<b>Venus 4 Sport</b>

Description	Dimensions	
	Venus 4 Sport	Venus 4 Sport AIR
Max. speed	6 km/h	
Continuous driving distance range*	18 km	
Length	1040 mm	1060 mm
Width	550 mm	
Height	900 mm	
Folded / dismantled length	1040 mm (Rear frame: 390 mm, Front frame: 840 mm)	1060 mm (Rear frame: 370 mm, Front frame: 880 mm)
Folded / dismantled width	550 mm (Rear frame: 550 mm, Front frame: 375 mm)	550 mm (Rear frame: 550 mm, Front frame: 480 mm)
Folded / dismantled height	Rear frame: 330 mm; Front frame: 450 mm	
Total mass	55,9 kg	56,15 kg
Mass of heaviest part (that can be dismantled or removed)	47,8 kg (without seat) or 34,25 kg (without seat and batteries)	48 kg (without seat) or 34,5 kg (without seat and batteries)
Masses of parts that can be dismantled or removed.	<b>Seat:</b> 8,1 kg; <b>Batteries:</b> 13,55 kg; <b>Basket:</b> 0,4 kg; <b>Armrests:</b> 1,35 kg/piece; <b>Frame:</b> rear frame 12,85 kg, front frame 20,1 kg	<b>Seat:</b> 8,1 kg; <b>Batteries:</b> 13,55 kg; <b>Basket:</b> 0,4 kg; <b>Armrests:</b> 1,35 kg/piece; <b>Frame:</b> rear frame 13,55 kg, front frame 20,7 kg
Maximum safe slope	6°	
Obstacle climbing	50 mm	
Ground clearance	30 mm (anti-tipping)	
Seat plane angle	4°	
Effective seat depth	340 mm	
Seat surface height at front edge (measured from ground)	520 - 570 mm	
Seat surface height at front edge (measured from footplate)	360 - 410 mm	
Height footplate	154 mm	
Backrest angle	6° (Not foldable)	
Backrest height	360 mm	
Distance between armpad and seat	240 mm	
Front location of armrest structure	370 mm	
Motor	Nom. 270 Watt, electromagnetic brakes	
Batteries	20 Ah	
Controller	70A	
Nominal voltage (battery)	2 x 12V ---	
Degree of protection	Not available	
Battery charger	2 Amp (external)	
USB connection	NO	YES



<b>Brand</b>	Vermeiren
<b>Type</b>	Rear wheel drive scooters, Class A
<b>Maximum load</b>	115 kg
<b>Model</b>	Venus 4 Sport

Description	Dimensions	
	Venus 4 Sport	Venus 4 Sport AIR
Battery charger protection class	IPx1	
Battery charger insulation class	II	
Minimum turning diameter	2960 mm	
Reversing width	1600 mm	
Diameter rear wheels (number)	230 x 75 mm (2)	210 x 75 mm (2)
Tyre pressure, rear (driving) wheels	NA	Max. 1,7 bar
Diameter steering wheels (number)	230 x 75 mm (2)	210 x 75 mm (2)
Tyre pressure, steering wheels	AN	Max. 1,7 bar
Storage and use temperature	+5 °C to +41 °C	
Operating temperature of the electronics	-10°C to +40°C	
Storage and use humidity	30%	

**We reserve the right to introduce technical changes. Measurement tolerance  $\pm 15$  mm / 1,5 kg / 1,5°.**

**\* The theoretical driving distance will be reduced if the scooter is used frequently on slopes, rough ground or to climb curbs. Maximum driving distance is based on an ambient temperature of 20°C, a 115 kg driver and a brand new fully recharged battery by a constant driving speed at 6 km/h with 70% battery power discharged.**

*Table 1: Technical specifications*

## 1.4 Accessories

The following accessories are available for the scooters Venus 4 Sport:

-  **WARNING: Risk of injury - Be sure that crutches are attached very well and cannot fall on the user.**

Crutch holder



## 1.5 Components



- 1 = Backrest
- 2 = Armrest / Armpad
- 3 = Seat
- 4 = Rear frame
- 5 = Anti-tipping
- 6 = Rear wheels
- 7 = Battery housing
- 8 = Footplate
- 9 = Front wheel
- 10 = Starknob angle adjustment steering column
- 11 = Shopping basket
- 12 = Speed lever
- 13 = Handgrips
- 14 = Operator panel
- 15 = Seat rotation lever
- 16 = Front light
- 17 = Freewheel lever

Venus 4 Sport AIR:



## 1.6 Location identification plate

Remove the battery housing to see the identification plate. The location of the identification plate is on the frame underneath the battery housing.

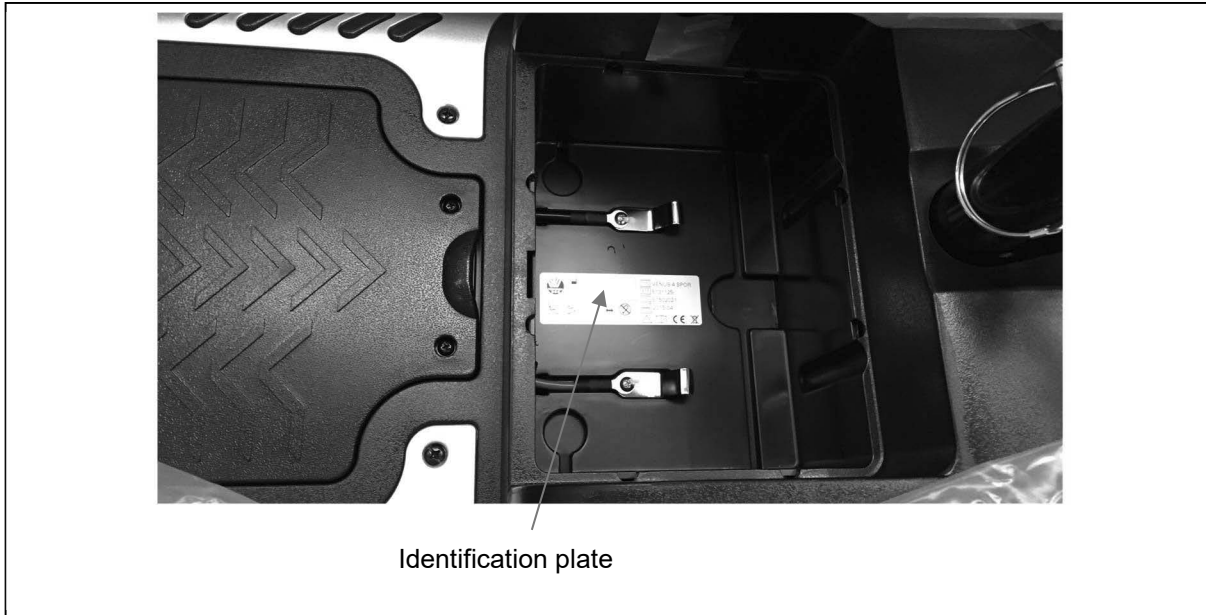

## 1.7 Explanation of symbols



Maximum mass



Outdoor use



Indoor use (only for battery charger)



Separate recovery and recycling of electric and electronic devices (only for battery charger)



Protection class II



Maximum safe slope



CE conformity



Maximum speed  
km/h



Not intended to be used as a seat in a Motor vehicle



Type designation

## 2 Use

This chapter describes the everyday use. **These instructions are for the user and the specialist dealer.**

The scooter is delivered fully assembled by your specialist dealer. The instructions intended for the specialist dealer on how to set up the scooter are given in § 3.

### 2.1 Remarks on electromagnetic compatibility (EMC)

Your scooter has been tested according ISO 7176-21.

We wish to point out that sources of electromagnetic waves (e.g. cell phones) are liable to create interferences. The electronics of the scooter itself could affect other electric appliances too.

To reduce the effect of electromagnetic sources of interference, please read the following warnings:

**⚠ WARNING: The scooter might disturb the operation of devices in its environment that emit electromagnetic field.**

**⚠ WARNING: The driving performance of the scooter can be influenced by electromagnetic fields (e.g. electricity generators or high power sources).**

**⚠ WARNING: Avoid using any portable TV or radio in the immediate environment of your scooter for as long as it is turned on.**

**⚠ WARNING: Avoid using any transmitter-receiver or cell phones in the immediate environment of your scooter for as long as it is turned on.**

**⚠ WARNING: Check the area for transmitter masts and avoid using the scooter close to them.**

**⚠ WARNING: If involuntary movements or braking occur, turn off the scooter as soon as it is safe to do so.**

**Interfering electromagnetic fields may have a negative effect on the scooter's electronic systems. These can include:**

- Disengagement of the engine brake
- Uncontrollable behavior by the scooter
- Unintentional steering movements

In the presence of very strong or enduring interfering fields, the electronic systems could even break down entirely or suffer permanent damage.

Possible sources of radiation include:

- Portable receiver and transmitter installations (receiver and transmitter with fixed antenna mounted directly on the transmitting unit)
  - Transmitting and receiving sets
  - Cell phones or "walkie talkie"
  - portable TV, radio and navigation devices
  - other personal transmitting devices
- Mobile medium-range transmitting and receiving devices (e.g. car antennas, with the antenna mounted on the outside of the vehicle)
  - Fixed transmitting and receiving sets
  - Fixed mobile transmitting and receiving devices
  - Fixed radio, TV and navigation systems
- Long-range transmitting and receiving devices
  - Radio and television towers
  - Amateur radio sets

Other home devices like CD player, notebook, cordless phones, AM/FM radios, electric shavers and hair dryers, so far as we know, will have no influence provided that they function perfectly and their cabling be in an excellent condition. Please conform to the operating instructions accompanying such electric instruments to ensure trouble free operating of your scooter.

1. Do not operate hand-held (transceivers-receivers), such as citizens band (CB) radios, or turn ON personal communication devices, such as cellular phones, while the powered vehicle is turned ON;
2. Be aware of nearby transmitters, such as radio or TV stations, and try to avoid coming close to them;
3. If unintended movement or brake release occurs, turn the powered vehicle OFF as soon as it is safe;

4. Be aware that adding accessories or components, or modifying the powered vehicle, may make it more susceptible to EMI (Note: There is no easy way to evaluated their effect on the overall immunity of the powered vehicle);

The intensity of the interfering EM energy can be measured in volts per meter (V/m). Each powered vehicle can resist EMI up to a certain intensity. This is called its "immunity level". The higher the immunity level, the greater the protection. At this time, current technology is capable of achieving at least a 20 V/m immunity level, which would provide useful protection from the more common sources of radiated EMI. This powered vehicle model as shipped, with no further modification, has an immunity level of 20 V/m without any accessories.

## 2.2 Carrying the scooter

Switch the power OFF with the key before carrying or moving the scooter. The weight of the frame and steering column is 49,5 kg (with batteries) or 35,9 kg (without batteries). Carry the frame + steering column with 2 persons to the desired place. Take the frame on the chassis, and not by the bumpers or the plastic parts. Only on the fixed parts from the frame.

The best way to carry the scooter is to make use of neutral mode of the scooter. Place the scooter in neutral and roll the scooter to the desired place.



If this is not possible or you are on your own, you can carry the scooter by following steps:

1. Switch the scooter off.
2. Remove loose parts (seat, battery housing, shopping basket).
3. Store loose parts in a safe place.
4. Dissassembly the rear and front frame.

## 2.3 Assembly and disassembly of the scooter

- ⚠ **WARNING:** Risk of injury - Make sure that all parts are assembled properly.
- ⚠ **WARNING:** Risk of injury - Assembly and disassembly must be done by trained personnel (e.g. specialist dealer).
- ⚠ **WARNING:** Risk of injury - Be careful not to cut or bruise yourself with the cables.
- ⚠ **WARNING:** Risk of injury - Turn the scooter off before disassembly / assembly.
- ⚠ **WARNING:** Risk of injury - Secure the starknob of the steering column after assembly of your scooter.
- ⚠ **CAUTION:** Risk of pinching - Do not place fingers between the components of the scooter (frame, backrest).



The scooter can be disassembled into four pieces: the seat, the front frame, the rear frame and battery housing, without any tools.

**To disassemble, please proceed as follows:**

- Switch the scooter off.
- Check that the scooter is placed in driving with the freewheel device lever (see "Neutral" chapter).
- Fold the backrest to the front (see "Folding the backrest" chapter).
- Remove the seat (see "Adjusting the seat" chapter).
- Unlock the battery housing and lift these out the scooter (see "changing the batteries" chapter).
- Lock the front wheels by pushing this lever down (see "locking steering wheels" chapter).
- Remove the shopping basket (see "Mounting / removing the shopping basket" chapter).
- Fold the steering column down (see "Adjusting angle of the steering column" chapter).
- Remove the rear and front frame out each other (see "Mounting or removing the rear and front frame" chapter).

**To reassemble, please proceed as follows:**

- Mount the front and rear frames in each other (see "Mounting or removing the rear and front frame" chapter).
- Move the steering column upwards (see "Adjusting angle of the steering column" chapter).
- Mount the shopping basket (see "Mounting / removing the shopping basket" chapter).
- Unlock the front wheels (see "locking steering wheels" chapter).
- Mount the battery housing (see "changing the batteries" chapter).
- Mount the seat (see "Adjusting the seat" chapter).
- Fold the backrest to the back (see "Folding the backrest" chapter).
- Place the freewheel drive lever in driving (see "Neutral" chapter).

## 2.4 Operating the brakes

Let go of the joystick to stop the scooter and activate the regular brakes / electromagnetic brakes.

## 2.5 Transfer in and out the scooter

1. Park the scooter as close as possible to the place where you want to transfer.
2. Check that the control panel (scooter) is switched off.
3. If necessary: put the armpad on the side you want to transfer upwards.
4. Transfer to / from the seat of the scooter.

## 2.6 Correct position in the scooter

Some recommendations for a comfortable use of the scooter:

1. Position your backside as close as possible to the backrest.
2. Make sure your upper legs are horizontal.

## 2.7 Driving the scooter

**⚠ WARNING: Risk of burns – Be careful when driving in hot or cold environments (sunshine, extreme cold, saunas, etc.) for a sufficient amount of time and when touching - Surfaces can assume the environment temperatures.**

**⚠ WARNING: Risk of unsafe settings - Use only the driving characteristics described in this manual.**

### 2.7.1 Preparing the scooter for use

When you use your scooter for the first time, make sure that it is standing on level ground. All wheels must be in contact with the ground.

1. For first time use, fully recharge the batteries.
2. Make sure that the motor is engaged.
3. Set the steering column in the most comfortable position (angle) for yourself and make sure it has been secured properly.
4. See that the seat has been locked in the driving position.
5. Sit down on the seat and verify that both armpads are folded down so you can rest your arms on them.
6. Insert contact key and turn clockwise, please wait for at least 3 seconds before you press the speed lever otherwise you have a "delay protection" alarm.
7. Check the battery indicator and see that there is enough power for your trip. If not enough capacity recharge the batteries before departure.

Now put the speed switch on the operator control to the minimum position. Your scooter is now ready for use. Only use higher speed setting when you are confident that you can easily operate and control your scooter.

Before using the scooter in busy or potentially dangerous areas, familiarize yourself with the operation of your scooter. Please practice in a wide and open area like a park.



## 2.7.2 Handling after usage

Before getting off from your scooter, make sure that all four wheels touch the ground simultaneously. Next turn the key to the "OFF" (charge indicator goes out) to turn off the integrated light.

## 2.7.3 Parking the scooter

Once your scooter has been turned off, no command can be sent to the driving system. You will be unable to deactivate the electromagnetic brakes before turning on your scooter again. Always park your scooter on sites that are well guarded or clearly visible.

When parking your scooter, be sure you park the scooter on flat ground.

## 2.7.4 Your first trip

**⚠ WARNING: Control your scooter - Accustom yourself with the driving behavior of your scooter.**

**⚠ WARNING: Control your scooter - Do not use both sides of the speed lever simultaneously. This might leave you unable to control your scooter.**

**⚠ WARNING: Control your scooter, risk of injury - Do not adjust the speed while you are driving.**

- Driving

Once you are seated on your scooter and have started it as described above, take hold of the handgrips with both hands, put your fingers to pull the speed lever in the required direction, i.e.:

PULL ACTION BY THE RIGHT HAND	=	FORWARD MOVEMENT
PULL ACTION BY THE LEFT HAND	=	BACKWARD MOVEMENT

While using your scooter indoor, do not put your scooter in the highest speed.

The speed lever allows you to control the speed of the scooter up to a maximum speed. The further the speed lever is deflected, the faster the scooter will go.

- Driving on the pavement

Ensure the limit switch is set to the slowest setting when using the scooter on the pavement. The maximum speed to drive on the pavement depends from country to country. Check the traffic law from the relevant country.

- Braking

To brake, let go of the speed/drive lever, which will let it return to the zero position and slow down your scooter to a gentle stop. Practice pulling away and braking to get accustomed to the scooter. You need to be able to estimate how your scooter will react when you drive or brake.

Do not turn your scooter "OFF" while driving as this will lead to an emergency stop and possible risk of accident and injury. The stopping distance will vary with your forward / reverse speed. Therefore please begin braking as early as you can.

- Driving in corners and bends

**⚠ WARNING: Risk of tipping over - Reduce your speed before you enter a curve or corner.**

**⚠ WARNING: Risk of clamping - Always maintain an adequate distance from corners and obstacles.**

**⚠ WARNING: Risk of tipping over - Do not drive your vehicle in an "S" pattern or make erratic turnings.**

For corners and bends, use both hands to turn the handle bar in the direction you wish to take. The front wheels will turn accordingly and steer the scooter into a new direction. It is very important that you ensure that there is enough space allowing you to go around bends and corners. Narrow passages must preferably be approached in a large curve so as to allow you to enter the narrowest part as straight from the front as possible. Bear in mind that your scooter's back part will in most cases be wider than the front part.

Take care not to enter curves and corners diagonally. By 'cutting the corner', chances are that your rear wheels will run into obstacles and destabilize your scooter.

### 2.7.5 Backward movement

- ⚠ WARNING: Control your scooter - Accustom yourself with the driving behavior of your scooter.**
- ⚠ WARNING: Control your speed - Always go backward in the lowest speed possible.**
- ⚠ WARNING: Risk of collision - Always look to the back when you go backward.**
- ⚠ WARNING: Risk of injury - Be sure no people or objects are behind you while reversing the scooter.**

Rearward driving requires increased concentration and care (LEFT HAND ACTION). This explains why we have greatly reduced the speed of rearward movement in comparison with forward driving. But we still recommend that you put the speed lever on minimum when you drive backward.

Do not forget that the steering direction with rearward driving is the opposite of when you go forward, and that your scooter will turn directly in the required direction.

When you are driving backwards the scooter makes a sound.

### 2.7.6 Going uphill

- ⚠ WARNING: Control your scooter - Accustom yourself with the driving behavior of your scooter.**
- ⚠ WARNING: Control your scooter - Never put your scooter in neutral on slopes.**
- ⚠ WARNING: Control your speed - Moving on slopes as fast as possible.**
- ⚠ WARNING: Risk of tipping over - Do not exceed the maximum gradient of static stability uphill (see paragraph "Technical specifications").**
- ⚠ WARNING: Never reverse going uphill.**

Always approach slopes directly from the front and, to avoid tipping over, see that all four wheels stay in contact with the ground at all times (ramps, driveways, etc.). Always lean forward when climbing a steep gradient. Your scooter is powered through a differential. Both drive wheels should therefore stay in contact with the ground at all times. Should one of the drive wheels no longer be in contact with the ground, a safety device will cut the transmission of energy to the wheels, bringing the scooter to a halt.

If you come to a stop on a slope by letting go of the accelerator, the engine break will prevent your scooter from rolling backward. As soon as the accelerator returns to zero position, the engine break is activated.

To resume your uphill drive, pull the speed lever open fully to ensure the release of a sufficient amount of power. This will allow your scooter to slowly ascend the slope.

If your scooter is unable to drive up, turn the speed control up and try again.

When driving on a gradient, the battery indicator light might move up and down. This is a normal phenomenon so please do not worry.

### 2.7.7 Going downhill

- ⚠ WARNING: Control your scooter - Accustom yourself with the driving behavior of your scooter.**
- ⚠ WARNING: Control your scooter - Never put your scooter in neutral on slopes.**
- ⚠ WARNING: Control your speed - Moving on slopes as slow as possible.**
- ⚠ WARNING: Risk of tipping over - Avoid sharp bends.**
- ⚠ WARNING: Risk of tipping over - Do not exceed the maximum gradient of static stability downhill (see paragraph "Technical specifications").**

Always approach downhill slopes directly from the front. Slantwise approaches can lead to some of the wheels no longer staying in contact with the ground (danger of tipping over). If one of the rear wheels fails to make contact, the transmission of power will be cut and the scooter come to a standstill.

The weight of the scooter will increase your downhill speed. Turn the speed control down and adjust your speed to the conditions.

Avoid sharp bends on downhill slopes. The weight of your scooter could cause your scooter to lift up on one side or even fall over around bends.

## 2.8 Driving the scooter on ramps

- ⚠ **WARNING:** Risk of injury - Do not exceed the maximum load of the ramps.
- ⚠ **WARNING:** Risk of injury - Choose the correct ramps so there cannot be caused any injury or damage.
- ⚠ **WARNING:** Risk of injury - Note that the considerable weight of the electric scooter generated large reverse forces.
- ⚠ **WARNING:** Risk of injury - Be sure that the wheel height is high enough to get over the free height of the ramps. The scooter frame may not touch the ramps.

Should you wish to use ramps to drive over an obstacle or drive the scooter in the car / van, please note the following:

1. Find out from the manufacturer what the maximum load is for the ramps.
2. Drive on the ramps at the lowest speed possible.
3. If you want that your scooter only drives straight, it is possible to lock the front wheels (see "locking steering wheels" chapter).
4. See the instructions in the chapter "your first trip".

## 2.9 Driving the scooter over steps

It is possible to drive with your scooter over steps from 50 mm. Please start from 500 mm to take this step.



## 2.10 Operator control

- Put the ON/OFF key switch ② on (clockwise), please wait for at least 3 seconds before you press the speed lever otherwise you have a "delay protection" alarm.
- Now the battery level indicator ④ will light up and shows the current level of your batteries.
- Now turn the speed switch ⑤ to the desired driving speed.
- Grasp the handgrips ①.
- Pull the speed lever ⑦ with your fingers toward the handgrips ① (right lever for forward movement, left lever for backward movement).
- To sound the horn, press the horn button ③.
- To put on the front light, press the light button ⑥.
- To stop the scooter loosen the speed lever ⑦ under the operator control.

Vermeiren is responsible for the changes in the software. For changes in the software contact Vermeiren.



### 2.10.1 Venus 4 Sport



- |                      |                           |
|----------------------|---------------------------|
| 1. Handgrip          | 6. Front light button     |
| 2. Contact key       | 7. Speed lever (throttle) |
| 3. Horn              | 8. Front light (led)      |
| 4. Battery indicator | 9. Battery charger access |
| 5. Speed switch      |                           |

### 2.10.2 Venus 4 Sport AIR

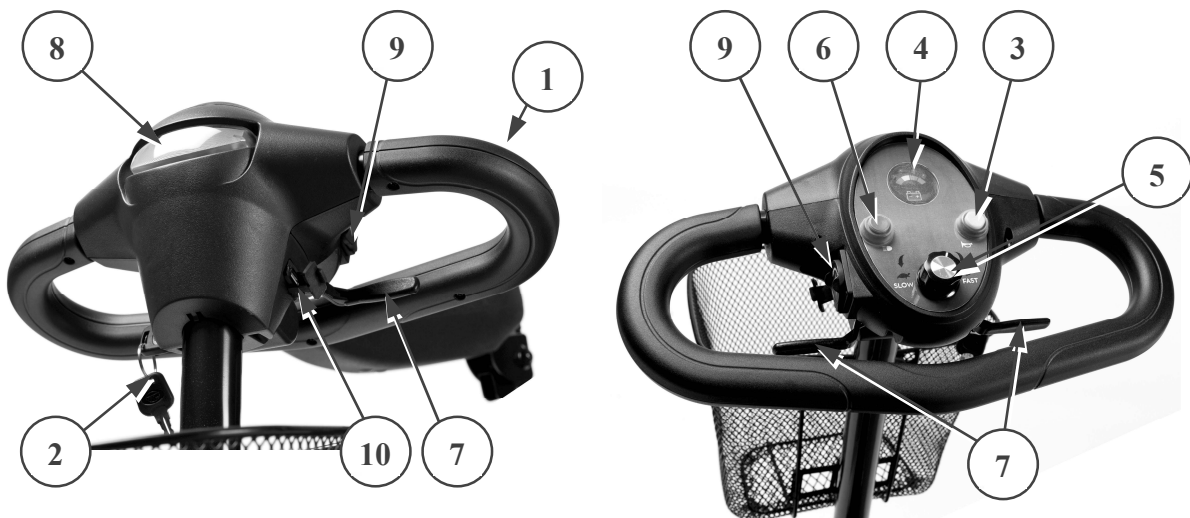

- |                      |                           |
|----------------------|---------------------------|
| 1. Handgrip          | 6. Front light button     |
| 2. Contact key       | 7. Speed lever (throttle) |
| 3. Horn              | 8. Front light (led)      |
| 4. Battery indicator | 9. Battery charger access |
| 5. Speed switch      | 10. USB charging station  |

Your Venus 4 Sport AIR scooter is equipped with a USB port (10) with 5V/1A charging station. It can be used to charge small appliances such as your phone.

## 2.11 Neutral

- ⚠ WARNING: Control your scooter - Never put your scooter in neutral while you are driving.**
- ⚠ WARNING: Control your scooter - Never put your scooter in neutral on slopes. It may accidentally roll away.**
- ⚠ WARNING: Risk of injury - Never pick up the electronic drive before stopping the motor/gears to prevent motor from overheating.**

The scooter is fitted with a freewheel device that is accessible and operable by the attendant or the user when not sitting in the scooter. You should only use the scooter in neutral to transport the scooter or to move it out of a danger zone. Put the scooter in neutral with the motor stop lever ① on the back side of the scooter.

- Driving
  1. Push the motor stop lever ① downwards to place the scooter in drive. This will again interlock the motor and gears.
  2. Switch the ON/OFF key ON.
  3. Electronically controlled driving is now possible.
- Neutral
  1. Switch the ON/OFF key OFF.
  2. Pull the motor stop lever ① upwards to place the scooter in neutral. This separates the motor from the gears.
  3. The scooter can now be pushed without electronic drive.



## 2.12 Transport in the car

- ⚠ DANGER: Risk of injury - The scooter is not suited for use as a seat in a motor vehicle.**
- ⚠ WARNING: Risk of injury - Remove all loose parts prior to transportation.**
- ⚠ WARNING: Risk of injury - No people or objects should be under the scooter, on the footplate or seat during transportation.**
- ⚠ WARNING: Risk of injury - See that the scooter is attached properly. So you can avoid injury from the passengers during collision or sudden braking.**
- ⚠ WARNING: Chance of pinching - Do not place fingers between the components of the scooter.**

The best way to transport your scooter fully assembled in the car is to drive the scooter in the car by using ramps. When you are not experienced to drive the scooter by using of ramps you can also put the scooter in neutral mode and push the scooter in the car by using ramps. Attach the frame of the scooter securely to the vehicle.

When the scooter does not fit in the car it is also possible to transport the scooter by the following steps:

1. Remove all loose parts prior to transporting (seat + backrest, battery housing, shopping basket, rear frame from front frame).
2. Store loose parts safely.
3. Fold the steering column down with the angle adjustment.
4. Place the separate parts in the car and attach them securely to the vehicle if necessary.

## 2.13 Automatic Power shut down

In order to avoid accidental battery run down, your scooter is equipped with an automatic power shut down facility. If the scooter is switched on, after remaining undisturbed for a period of ten minutes it will automatically turn off (you hear a warning sound, the red LED is not lit and your scooter is not reacting). Should this occur, simply switch your scooter off and back on and it will be ready to use once again.

## 2.14 Charging the batteries

**⚠ WARNING: Risk of injury - Take out the key before you start charging.**

**⚠ WARNING: Risk of fire - Keep away from flammable objects while charging as it may lead to fire of battery.**

**⚠ WARNING: Risk of electrical shock - Never connect or disconnect the plug or cable with wet hands while charging.**

Fully recharge your new battery before its first time use.

The light emitting diode (LEDs) in the steering column indicates the remaining capacity of your batteries. If the battery charger is turned on and no LED's are lit, check the fuse. If the red LED does not illuminate the charger is defective, consult your specialist dealer.

Recharge the batteries on a daily basis and in a well-ventilated space, not directly exposed to sunlight. Do not charge in surroundings where it is humid or under rainfall and morning dews. If you do not do that and you keep on driving, the output of your scooter will drop very significantly (uphills, bends, dim headlights). If you ignore these signals too, your scooter will turn off. You should now immediately recharge your scooter with the accompanying battery charger. Be sure that you charge the battery fully every time.

After charging or replacing a new battery, drive the vehicle for 2-3 minutes to make sure the battery capacity is sufficient.

The battery capacity will vary by how you drive with your scooter (repeated starting, stopping, climbing, rough terrain) and will consume the capacity more quickly. In wintertime, the battery may respond more slowly and the battery range may be reduced.

Kindly also observe the accompanying operating instructions.

Primary	230V ~ / 50-60 Hz / 270 W max.
Secondary	24 V --- / 2A max.
Max. battery cap.	20 Ah
Charging	Charge 80% cap. within 8 hrs



### Method 1: On board charging:

1. Turn the key to OFF and take it out.
2. Open the protecting cap of the charging socket ①.
3. Insert the plug of the charger into the charging socket of the scooter.

### Method 2: Off board charging:

1. Turn the key to OFF and take it out.
2. Remove the battery housing out the scooter by the handgrip.
3. Insert the plug of the charger into the charging socket of the battery pack ①.

4. Insert the mains plug of the charger into the power socket. Switch the charger to ON (a few models have no ON/OFF switch; with these the loading device starts operating automatically when you insert the mains cable).
5. The charger now starts to charge and the LED (red and orange) will be lit, which indicates that it is busy charging. While charging your scooter it is not possible to run, drive your scooter because the immovable function will be activated.
6. Once the charging process is complete, the LED (orange) turns green, thereby indicating that loading is complete. The charging duration is about 6 hours. To ensure optimum performance a 10-hour charge is recommended. But we do not recommend a charging more than 24 consecutive hours.
7. First switch off the charger (if there is no ON/OFF switch, pull out the mains plug).

8. Pull out the charger out the power socket.
9. Pull out the charger plug from the charging socket of the scooter. Your scooter is again ready for use.
  - Charge your scooter's batteries strictly in accordance with the description above. If you charge the batteries too early, they will gradually lose capacity, thus cutting your scooter's traveling range.
  - The manufacturer shall decline all liability for damage caused by incorrect charging.
  - Use only genuine original batteries. We do not accept any liability for damage caused by using batteries not supplied by us.
  - Do not expose the batteries to temperatures below  $-10^{\circ}$  Celsius or above  $50^{\circ}$  Celsius.
  - If the batteries are opened, all liability of the manufacturer is voided as well as any claim.
  - After charging do not leave the charger socket plugged into the scooter, as this will cause a power drain on the scooter and temporarily reduce its range.

If you decide not to use your scooter for a prolonged period, you must nevertheless recharge it regularly to keep it in a running condition ready for immediate use.

- If the batteries are not being used for a prolonged period, they will discharge slowly by themselves (in-depth discharging). Then it becomes impossible to recharge them with the supplied battery charger. When batteries are not in use, they must be recharged at least every 4 to 8 weeks (depending on the charge indicator).
- Note that if you recharge the batteries too frequently, they will eventually lose their capacity irretrievably.
- Use only the supplied battery charger and no other charging equipment.
- The manufacturer shall decline all liability for damage caused by improper charging.
- In every case the charging cycle must not be interrupted. The battery charger has an indicator showing you when the charging cycle has been completed.
- Do not charge any other electrical equipment with your scooter's battery or battery charger.

## 2.15 Battery indicator

The battery indicator on the steering column uses a color code to indicate the approximate power remaining in your batteries. Green indicates (40~100%) capacity, yellow a draining charge (10~30%), and red indicates that an immediate recharge is necessary.

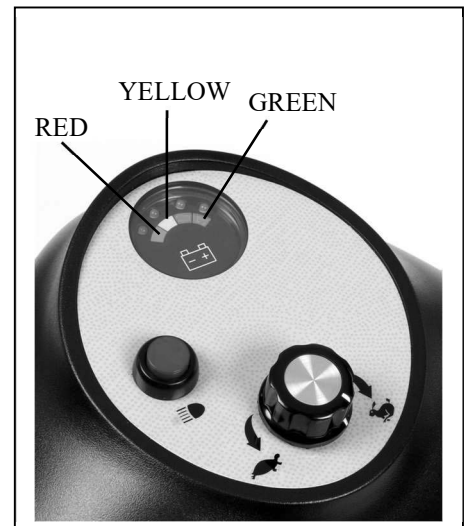

## 3 Installation and adjustment

The instructions in this chapter are for the user and the specialist dealer.

To find a service facility or specialist dealer near you, contact the nearest Vermeiren facility. A list of Vermeiren facilities can be found on the last page.

**⚠ WARNING: Risk of unsafe settings - Use only the settings described in this manual.**

**⚠ WARNING: Risk of tipping over - Variation allowed adjustments can still change the stability of your scooter (tilt back or sideways).**

### 3.1 Tools

To set up the scooter no tools are needed.

### 3.2 Manner of delivery

The scooter shall be delivered with:

- Frame with armrests, steering column, rear and front wheels, anti-tipping wheels
- Footplate
- Seat + backrest
- Batteries, motor
- Battery charger
- Shopping basket
- Manual

### 3.3 Mounting or removing the rear and front frame

**⚠ WARNING: Risk of injury - Be carefull that you do not pinch your fingers, hands between the frame.**

**⚠ CAUTION: Risk of injury - Check that the front and rear frame is fixated properly.**



Mounting frame:

1. Place the rear frame with the electronic parts pointed upwards. Now you see orange marked hooks.
2. Grasp the red lever ① located on the front frame. On the front frame there are orange marked pens.
3. Mount the front ① and rear frame ② into each other, by mounting the orange pens in the orange hooks.
4. Turn the rear frame towards the front frame until it clicks into each other.
5. Check that the front ① and rear frames ② are firmly secured, so these cannot rotate or move anymore.

Removing rear frame:

1. Pull the red lever ① upwards.

2. Pull the front frame upwards.
3. Turn the rear frame handrips towards the ground so the electronic parts are pointed upwards.
4. The pens of the front frame has flat edges, meaning is that these edges are parallel with the hook edges of the rear frame. Now lift the front frame upwards and you can easily take the front frame out the rear frame.

### 3.4 Adjusting angle of the steering column

The steering column can be adjusted in different angles to suit each driver.

**⚠ WARNING: Risk of injury - Never adjust the angle while you are driving.**

**⚠ WARNING: Risk of injury - Turn the scooter off before you adjust the angle of the steering column.**

**⚠ WARNING: Risk of injury - Do not lean with your whole body on the steering column.**

**⚠ CAUTION: Risk of injury - Grasp the steering column before loosen the starknob.**



1. Loosen the starknob ①.
2. Adjust the steering column in the desired position.
3. Tighten the starknob ① to secure the steering column.

### 3.5 Mounting / removing the shopping basket

Mounting shopping basket:

1. Grasp the shopping basket.
2. Mount the shopping basket with the holes on the hooks of the attachment plate.
3. Check the shopping basket is mounted very well.

Removing shopping basket:

1. Grasp the shopping basket.
2. Pull the shopping basket upwards until it comes out the hooks of the attachment plate.

### 3.6 Adjusting the seat

**⚠ WARNING: Risk of injury - Never perform adjustments while you are driving.**

**⚠ WARNING: Risk of injury - Make sure that the seat is locked securely.**

#### Remove seat (Fig. A)

1. Pull the seat lever ① upwards.
2. Turn the seat ② a little bit and lift the seat out the adjustment bar ③.
3. Release the seat lever ①.

#### Lock the seat in place (Fig. A)

1. Pull the seat lever ① upwards.
2. Place the seat ② on the adjustment bar ③ and at the same time keep the seat lever ① pressed in.
3. Release the seat lever ①.
4. Check that the seat ② is firmly secured.

#### Swivel seat (Fig. A)

1. Pull the seat lever ① upwards.
2. Turn the seat ② in the desired direction (the seat can be locked in a position at 45° intervals).
3. Release the seat lever ①.
4. Check that the seat ② is firmly secured.

Fig. A



- 1 = Seat lever
- 2 = Seat
- 3 = Adjustment bar

**Seat height adjustment (Fig. B)**

**The seat can be adjusted in 2 different seat heights (increments: 50 mm).**

1. Remove the seat from the adjustment bar ③.
2. Loosen the starknob ② a little bit.
3. Remove the safety pin ①.
4. Move the adjustment bar ③ upwards/downwards in the receiver, and place this in a comfortable seat height.
5. Replace the safety pin ①.
6. Fasten the starknob ② and check that the play of the seat is reduced.
7. Replace the seat on the adjustment bar ③.
8. Check the seat is locked securely.

Fig. B

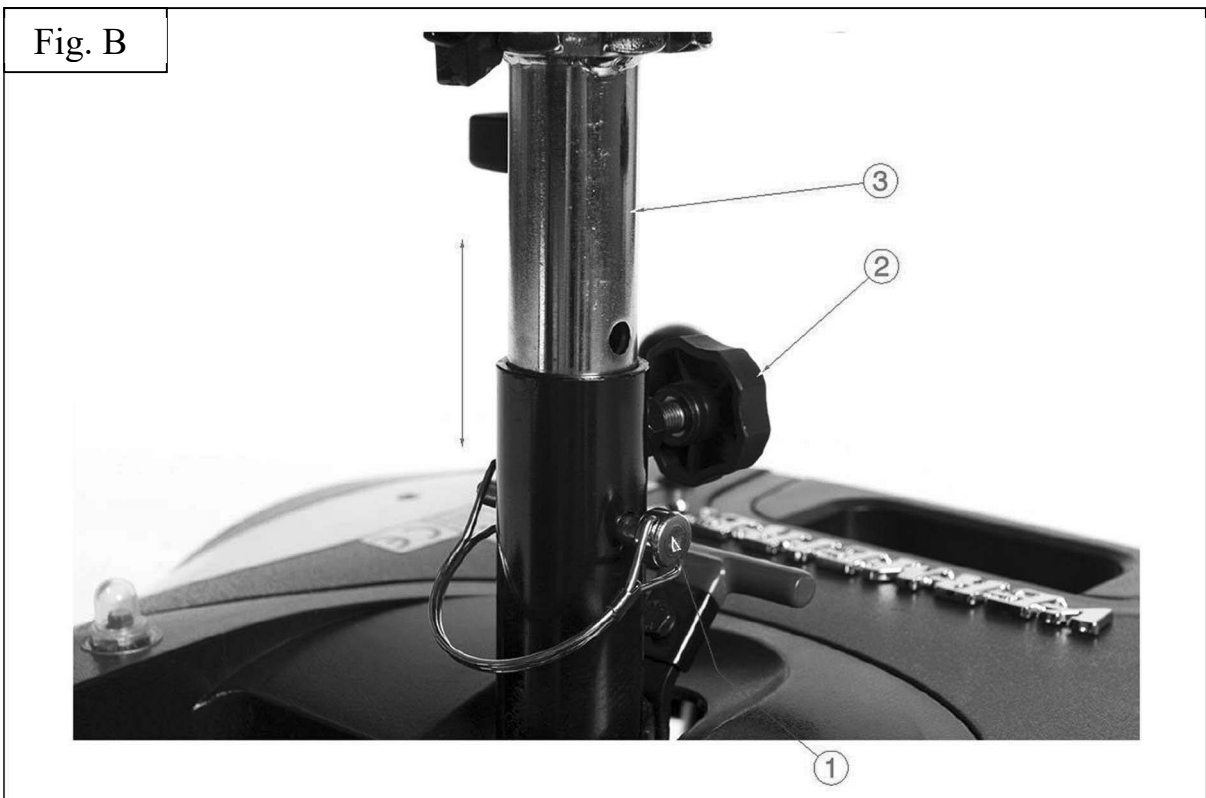

### 3.7 Folding the backrest



- ⚠ **WARNING: Risk of injury - Never perform adjustments while you are driving.**
- ⚠ **WARNING: Risk of injury - Be careful you do not pinch your fingers at the rear of the backrest when pulling the backrest in the upright position. see label:**



Push the backrest forward to fold the backrest to the front.  
Pull the backrest backwards to place the backrest in the upright position.

### 3.8 Adjusting the armrests

- ⚠ **CAUTION: Risk of tipping over - Make sure that the armrests are positioned symmetrically from the seat.**
- ⚠ **CAUTION: Risk of injury - Mount the inner tube always with of safe distance of 50 mm in the outer tube.**

The armrest can be adjusted in width:

1. Loosen the star knob ① on the back of the scooter.
2. Grasp the inner square tube.
3. Move these tube to adjust the armrest ② to the desired width (range: 100 mm each side stepless).
4. Retighten the star knob ①.
5. Check that the armrest is fixated very well.

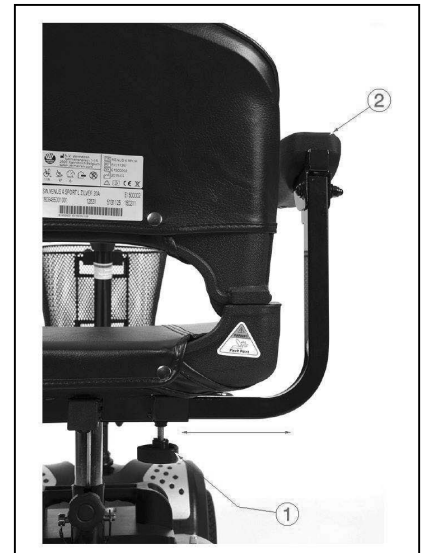

### 3.9 Locking steering wheels

- ⚠ **CAUTION: Risk of injury - Put the steering wheels back on unlocked when you want to drive with your scooter.**

When you want to place the scooter fully assembled in the car you can lock the steering wheels.

1. Push the lever ① downwards.

When you want to drive with your scooter you **MUST** first unlock the steering wheels.

1. Pull the lever ① upwards.
2. Now you can turn the steering wheels.





### 3.10 Tyre changing

- ⚠ CAUTION: There must be no air in the tube before it can be removed.**
- ⚠ CAUTION: Risk of damage - If handled improperly, the rim might be damaged.**

If you want to change the tyres or inner tubes, you should note the following:

Before you can remove a tyre, you must let all the air out of the tube, and insert a tyre lever between the tyre and the rim. Then slowly and carefully push the lever downwards. This will pull the tyre over the edge of the rim. If you then move the lever along the rim, the tyre will jump out. Now carefully remove the tyre from the rim and then remove the tube.

#### **Note the following before inserting the new tube:**

Check the rim bed and the inside wall of the tyre for foreign matter and clean these properly if necessary. Check the condition of the rim bed, especially around the position of the air valve. Please use only genuine original replacement parts. No liability is accepted for damage caused by non-genuine replacement parts. Kindly contact your specialist dealer.

#### **Assembly:**

- ⚠ WARNING: Risk of injury - Check that the pressure is correct.**
- ⚠ CAUTION: Risk of injury - Make sure that no objects or body parts are pinched between the tyre and the rim when mounting a tyre.**

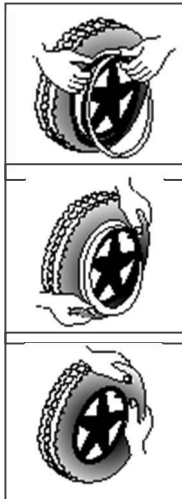

Put the deflated tube around the center of the rim. Make sure that the valve juts out the valve opening in the rim.

Push the tyre over the edge of the rim, starting behind the air valve. Inflate the tube slightly until it is round, and place it inside the tyre.

If the tube fits snugly inside the tyre without any folds (in the case of folds: let out some air), then the upper side of the tyre can be pressed lightly onto the rim with both hands, starting at the air valve.

Check all around on both sides that the tube is not pinched between the rim and the edge of the tyre. Lightly push the air valve inwards and pull it out again to make sure that the tyre is positioned properly in the region of the air valve.

To ensure that the wheel is inflated correctly, admit only so much air initially that the tyre can still be easily pushed inwards by using your thumbs. If the check-lines are equidistant from the edge of the rim on both sides of the tyre, then the tyre is centered properly. If not - let out the air and position the tyre afresh. Now the tyre can be inflated to its full operating pressure (note the maximum) and the valve cap should be replaced.

Only an expert can guarantee correct assembly. Work not done by your specialist dealer, would void any warranty claims.

When inflating the tyres, always check that the pressure is correct. The correct pressure is given on the tyre walls.

Use only inflating equipment which complies with regulations and indicates the pressure in bar. We do not accept any liability for damage caused by using inflation equipment not supplied by the manufacturer.

### 3.11 Thermal fuses



To protect the motor against overload, your scooter have a thermal safety mechanism ① on the right side of the battery housing. The thermal fuse will automatically cut the motor to prevent overheating and thus rapid wear and tear or breakdowns. You can access the thermal safety device through a gap in the back of the synthetic cover.

The thermal safety device can go loose if you go up or down slopes that exceed the maximum gradient indicated. Nominal loads that exceed the maximum permitted could also cause the device to jump out. The maximum values not to exceed are indicated in the chapter "Technical Specifications".

To be able to use the scooter again, remove the overload and wait till the motor has cooled off. Then gently press the thermal safety mechanism back in. Your scooter is now ready for use again.

### 3.12 Anti-tipping

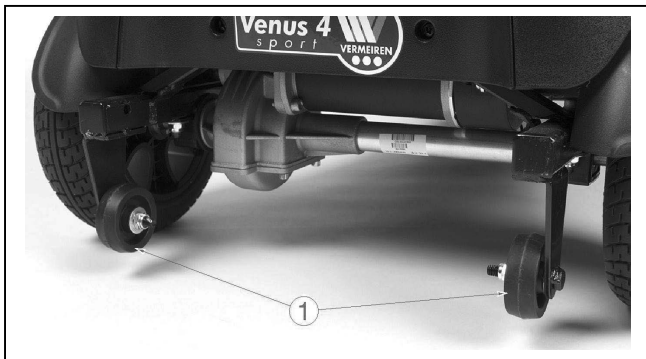

An anti-tipping ① is fixed to the frame of the scooter on the back side. It is not possible to remove this. The anti-tipping is there for your safety. It prevents the scooter from tipping over backward when you drive over small obstacles that do NOT exceed the maximum height specified.

### 3.13 Changing the batteries

**⚠ CAUTION: Risk of burns - Do not come in contact with the acid from the batteries. See for a good ventilation of the battery compartment.**

Even if the battery is used properly, it is natural for the battery's capacity to reduce with time, which results in reduced battery range compared to a brand new battery. Therefore, when you find the battery's range is about only 50% of the range when the batteries were new, it is time to replace the batteries. Please see your dealer about replacement batteries. If you continue to use the old battery when it should be replaced, it could lead to a rapid decline in performance. Replace both batteries together.

The battery shall be changed by trained personel.

The wiring is well situated in the scooter. Do not attempt to re-locate the wiring by yourself. The improper



installation of the wiring may result in pinching the wiring between the battery box, which cause failure to the electronic system of your scooter.

Be sure the battery cables are connected to the right battery.

Remove the battery housing:

1. Turn the switch ① to the unlock symbol. 
2. Now you can lift the battery housing out the scooter.

Mount the battery housing:

1. Place the battery housing in the scooter. 
2. Turn the switch ① to the lock symbol.
3. Check that the battery housing is firmly secured in the scooter, by lifting this gently upwards with the handgrip.

## 4 Maintenance

**i** Regular care ensures that your scooter is preserved in a perfectly functional condition. For the maintenance manual, refer to the Vermeiren website: [www.vermeiren.com](http://www.vermeiren.com).

 **CAUTION** Risk of injuries and damage

Repairs and replacements may only be undertaken by trained persons and only genuine replacement parts of Vermeiren should be used.

**i** The last page of this manual contains a registration form for the specialist dealer to record each service.

### **Before each use**

Visually inspect the following points:

- Battery status: Charge the battery when necessary, see § 2.14.
- Condition of wheels/tyres: Correct pressure, profile, no damage.
- General condition.

Contact your specialist dealer for possible repairs or part replacements.

### **Every month**

If your scooter is stored for a longer period, you still need to charge the batteries every month. For more information, see §2.14.

### **Yearly or more often**

Have your scooter inspected and serviced by your specialist dealer at least once a year, or more often. The minimum maintenance frequency depends on use and should therefore be commonly agreed upon with your specialist dealer.

### **If stored**

Make sure that your scooter is stored in a dry environment to prevent mould from growing or the upholstery from being damaged. Disconnect the battery to prevent it from being damaged.

## 4.1 Cleaning

 **CAUTION** Risk of damage by moisture

- Keep the operating console clean and protect it from water and rain.
- Never use a hose or high-pressure cleaner to clean the scooter.

Wipe all rigid parts of the scooter with a damp cloth (not drenched). If necessary, use a mild soap, suitable for varnishes and synthetics.

The upholstery can be cleaned with lukewarm water and a mild soap. Do not use abrasive cleaning agents to clean.

Keep the ventilation openings of the battery charger clean and free of accumulated dust. Blow away the dust and clean the battery charger enclosure with a slightly moistened cloth, if required.

## 4.2 Reuse

Before each reuse, have the scooter disinfected, inspected and serviced according to the instructions in the maintenance manual.

## 4.3 Expected lifespan

The scooter is designed to have an average lifespan of 5 years. Depending on the frequency of use, driving circumstances and maintenance, the lifespan of your scooter will increase or decrease.

## 4.4 End of use

At end of life, you need to dispose your scooter according to the local environmental legislation. The best way to do so, is to disassemble the scooter to facilitate the transport of recyclable parts. Usually, batteries are collected separately.





## Service registration form

This product (name): .....

was inspected (I), serviced (S), repaired (R) or disinfected (D):

<p>By (stamp):</p>   <p>Kind of work: I / S / R / D Date:</p>	<p>By (stamp):</p>   <p>Kind of work: I / S / R / D Date:</p>	<p>By (stamp):</p>   <p>Kind of work: I / S / R / D Date:</p>
<p>By (stamp):</p>   <p>Kind of work: I / S / R / D Date:</p>	<p>By (stamp):</p>   <p>Kind of work: I / S / R / D Date:</p>	<p>By (stamp):</p>   <p>Kind of work: I / S / R / D Date:</p>
<p>By (stamp):</p>   <p>Kind of work: I / S / R / D Date:</p>	<p>By (stamp):</p>   <p>Kind of work: I / S / R / D Date:</p>	<p>By (stamp):</p>   <p>Kind of work: I / S / R / D Date:</p>
<p>By (stamp):</p>   <p>Kind of work: I / S / R / D Date:</p>	<p>By (stamp):</p>   <p>Kind of work: I / S / R / D Date:</p>	<p>By (stamp):</p>   <p>Kind of work: I / S / R / D Date:</p>
<p>By (stamp):</p>   <p>Kind of work: I / S / R / D Date:</p>	<p>By (stamp):</p>   <p>Kind of work: I / S / R / D Date:</p>	<p>By (stamp):</p>   <p>Kind of work: I / S / R / D Date:</p>







Vermeiren GROUP  
Vermeirenplein 1 / 15  
2920 Kalmthout  
BE

website: [www.vermeiren.com](http://www.vermeiren.com)

### **Instructions for specialist dealer**

This instruction manual is part and parcel of the product and must accompany every product sold.

Version: C, 2020-10

Basic UDI: 5415174 122124Venus 4 Sp 6E

### **All rights reserved, including translation.**

No part of this manual may be reproduced in any form what so ever (print, photocopy, microfilm or any other process) without written permission of the publisher, or processed, duplicated or distributed by using electronic systems.

© Vermeiren Group 2020